

# Keysight Technologies 53131A/132A/181A Counters

Data Sheet

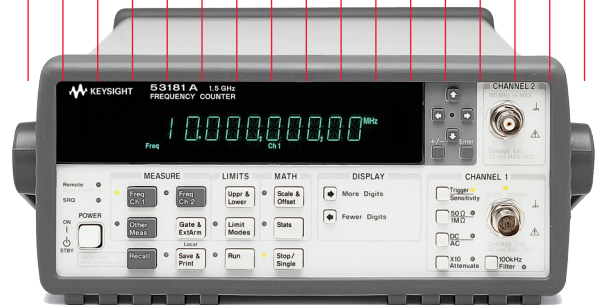
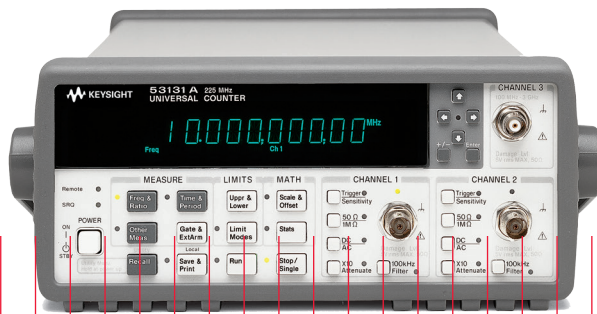

Recommended replacement products:  
53200 Series RF & universal frequency counter/timers  
(Data sheet publication number: 5990-6283EN)

## Overview

- 225 MHz bandwidth (optional 1.5, 3, 5, or 12.4 GHz)
- 10- or 12-digit resolution with 1 s gate time
- GPIB interface and IntuiLink connectivity software standard
- Data transfer rate of up to 200 fully formatted measurements/second

### A family of universal and RF counters to meet your needs

The Keysight Technologies, Inc. 53131A/132A/181A high-performance counters give you fast, precise frequency measurements at an affordable price. These counters feature an intuitive user interface and one-button access to frequently used functions so you can make accurate measurements quickly and easily.

Real-time digital signal processing technology is used to analyze data while simultaneously taking new readings, speeding measurement throughput. The technology, developed for Keysight's high-end line of modulation domain analyzers, allows the counters to gather more data for each measurement, so you get higher-resolution measurements in a fraction of the time it takes other counters.

The 53131A/132A/181A counters offer built-in statistics and math functions so you can scale measurements and simultaneously measure and track average, min/max and standard deviation. Automated limit testing lets you set upper and lower limits for any measurement. An analog display mode lets you see at a glance whether a measurement is within pass/fail limits. The counters flag out-of-limit conditions and can generate an output signal to trigger external devices when a limit is exceeded. For quick access to frequently used tests, a single keystroke recalls up to 20 different stored front-panel set-ups.

For computer-controlled systems applications, each counter includes a standard GPIB interface with full SCPI-compatible programmability and a data transfer rate of up to 200 fully formatted measurements per second. The standard RS-232 talk-only interface provides printer support or data transfer to a computer through a terminal-emulation program.

### Keysight 53131A universal counter

The two-channel 53131A counter offers 10 digits per second of frequency/period resolution and a bandwidth of 225 MHz. Time interval resolution is

specified at 500 ps. An optional third channel provides frequency measurements up to 3 GHz, 5 GHz, or 12.4 GHz. Standard measurements include frequency, period, ratio, time interval, pulse width, rise/fall time, phase angle, duty cycle, totalize, and peak voltage.

### Keysight 53132A universal counter

For applications requiring higher resolution, the 53132A offers the same features and functions as the 53131A, with up to 12 digits/sec frequency/period resolution and 150 ps time interval resolution. In addition, the 53132A offers advanced arming modes for time interval measurements.

### Keysight 53181A RF counter

Optimized for RF applications, the single-channel 10 digit/s 53181A measures frequency, period and peak voltage. A digit-blanking function lets you easily eliminate unnecessary digits when you want to read measurements quickly. For higher-frequency measurements, choose an optional second channel that provides measurements up to 1.5 GHz, 3 GHz, 5 GHz, or 12.4 GHz. A self-guided shallow menu makes this counter exceptionally easy to use.

## Keysight IntuiLink provides easy access to the counter's data from your PC

The Keysight 53131A/132A/181A counters, capture precise frequency and time measurements. IntuiLink software allows that data to be put to work easily. You work in a familiar environment at all times, using PC applications such as Microsoft Excel or Word to analyze, interpret, display, print, and document the data you get from the counter.

It gives you the flexibility to configure and run tests from your PC making data gathering more convenient.

Keysight IntuiLink lets you:

- Configure tests, including measurement type, number of readings, measurement speed, and more.
- Choose display modes from real-time strip chart, histogram, readout, and table mode.
- Scale measurements data.
- Copy captured data to other programs.

## Optional timebases offer increased stability

Optional timebases are available for 53131A/132A/181A counters to increase measurement accuracy. Option 010 provides a high stability oven timebase with aging of less than  $5 \times 10^{-10}$  per day.

## 3-year warranty

Each counter comes with operating, programming and service manuals, IntuiLink software, a power cord and a full 3-year warranty.

## Time base

Internal time base stability (see graph 3 for timebase contribution of measurement error)

		Standard (0° to 50°C)	Medium oven (Option 001)	High oven (Option 010)	Ultra high oven (Option 012 for 53132A only)
Temperature stability (referenced to 25°C)		$< 5 \times 10^{-6}$	$< 2 \times 10^{-7}$	$< 2.5 \times 10^{-9}$	$< 2.5 \times 10^{-9}$
Aging rate (after 30 days)	Per Day:		$< 4 \times 10^{-8}$	$< 5 \times 10^{-10}$	$< 1 \times 10^{-10}$
	Per Month:	$< 3 \times 10^{-7}$	$< 2 \times 10^{-7}$	$< 1.5 \times 10^{-8}$	$< 3 \times 10^{-9}$
	Per Year:				$< 2 \times 10^{-8}$
Turn-on stability vs. time (in 30 minutes)			$< 2 \times 10^{-7}$ referenced to 2 h	$< 5 \times 10^{-9}$ referenced to 24 h	$< 5 \times 10^{-9}$ referenced to 24 h
Calibration		Manual adjust	Electronic	Electronic	Electronic

Note that power to the time base is maintained when the counter is placed in standby via the front panel switch. The internal fan will continue to operate when in standby to maintain long-term measurement reliability.

# Instrument Inputs

## Input specifications

Channel 1 & 2 (53131A, 53132A) <sup>1</sup> Channel 1 (53181A)	
Frequency range	
dc coupled	dc to 225 MHz
ac coupled	1 MHz to 225 MHz (50 Ω) 30 Hz to 225 MHz (1 MΩ)
FM tolerance	25%
Voltage range and sensitivity (Sinusoid) <sup>2</sup>	
dc to 100 MHz	20 mVrms to ±5 V ac + dc
100 MHz to 200 MHz	30 mVrms to ±5 V ac + dc
200 MHz to 225 MHz	40 mVrms to ±5 V ac + dc (all specified at 75 mVrms with opt. rear connectors) <sup>3</sup>
Voltage range and sensitivity (Single-shot pulse) <sup>2</sup>	
4.5 ns to 10 ns pulse width	100 mVpp to 10 Vpp (150 mVpp with optional rear connectors) <sup>3</sup>
>10 ns pulse width	50 mVpp to 10 Vpp (100 mVpp with optional rear connectors) <sup>3</sup>
Trigger level <sup>2</sup>	
Range	± 5.125 V
Accuracy	± (15 mV + 1% of trigger level)
Resolution	5 mV
Damage level	
50 Ω	5 Vrms
0 to 3.5 kHz, 1 MΩ	350 Vdc + ac pk
3.5 kHz to 100 kHz, 1 MΩ	350 Vdc + ac pk linearly derated to 5 Vrms
>100 kHz, 1 MΩ	5 Vrms

## Input characteristics

Channel 1 & 2 (53131A, 53132A) <sup>1</sup> Channel 1 (53181A)	
Impedance	1 MΩ or 50 Ω
1 MΩ capacitance	30 pF
Coupling	ac or dc
Low-pass filter	100 kHz, switchable –20 dB at > 1 MHz
Input sensitivity	Selectable between Low, Medium, or High (default). Low is approximately 2x High Sensitivity.
Trigger slope	Positive or negative
Auto trigger level	
Range	0 to 100% in 10% steps
Frequency	> 100 Hz
Input amplitude	> 100 mVpp (No amplitude modulation)
Attenuator	
Voltage range	x10
Trigger range	x10

## Auto trigger level

Range	0 to 100% in 10% steps
Frequency	> 100 Hz
Input amplitude	> 100 mVpp (No amplitude modulation)
Attenuator	
Voltage range	x10
Trigger range	x10

## Input Specifications<sup>4</sup>

Channel 3 (53131A, 53132A) Channel 2 (53181A)	
Frequency range	
Option 015 (for 53181A only)	100 MHz to 1.5 GHz (see Opt. 030 for additional specs)
Option 030	100 MHz to 3 GHz
Option 050	200 MHz to 5 GHz
Option 124	200 MHz to 12.4 GHz
Power range and sensitivity (Sinusoid)	
Option 030	100 MHz to 2.7 GHz: –27 dBm to +19 dBm 2.7 GHz to 3 GHz: –21 dBm to +13 dBm
Option 050	200 MHz to 5 GHz: –23 dBm to +13 dBm
Option 124	200 MHz to 12.4 GHz –23 dBm to +13 dBm
Damage level	
Option 030	5 Vrms
Option 050	+25 dBm
Option 124	+25 dBm

## Characteristics

Impedance	50 Ω
Coupling	AC
VSWR	< 2.5:1

## External arm input specifications<sup>5</sup>

Signal input range	
TTL compatible	
Timing Restrictions	
Pulse width	> 50 ns
Transition time	< 250 ns
Start-to-stop time	> 50 ns
Damage level	10 Vrms

## External arm input characteristics<sup>5</sup>

Impedance	1 kΩ
Input capacitance	17 pF
Start/stop slope	Positive or negative
External time base input specifications	
Voltage range	200 mVrms to 10 Vrms
Damage level	10 Vrms
Frequency	1 MHz, 5 MHz, and 10 MHz (53132A 10 MHz only)

## Time base output specifications

Output frequency	10 MHz
Voltage	> 1 Vpp into 50 Ω (centered around 0 V)

- Specifications and characteristics for Channels 1 and 2 are identical for both common and separate configurations.
- Values shown are for X1 attenuator setting. Multiply all values by 10 (nominal) when using the X10 attenuator setting.
- When the 53131A or 53132A are ordered with the optional rear terminals (Opt. 060), the channel 1 and 2 inputs are active on both front and rear of the counter. When the 53181A is ordered with the optional rear terminal, the channel 1 input is active on both front and rear of the counter. For this condition, specifications indicated for the rear connections also apply to the front connections.
- When optional additional channels are ordered with Opt. 060, refer to configuration table for Opt. 060 under ordering info on page 8. There is no degradation in specifications for this input, as applicable.
- Available for all measurements except peak volts. External arm is referred to as external gate for some measurements.

For automatic or external arming:  
(and signals < 100 Hz using timed arming)

$$\text{LSD displayed: } \left( \frac{t_{res}}{\text{Gate time}} \right) \times \frac{\text{Frequency}}{\text{or period}}$$

$$\text{RMS resolution: } \left( \frac{\sqrt{t_{res}^2 + (2 \times \text{Trigger error})^2}}{\text{Gate time}} \right) \times \frac{\text{Frequency}}{\text{or period}}$$

	53131A $t_{res}$	53132A $t_{res}$	53181A $t_{res}$
typical	650 ps	200 ps	650 ps

see graphs for worst case resolution performance

For automatic arming:  $\text{Gate time} = \frac{N}{\text{Frequency}}$

where N = 1 for standard channel frequency < 1 MHz  
4 for standard channel frequency > 1 MHz  
128 for optional channel

$$\text{Systematic uncertainty: } \left( \pm \text{Time base error} \pm \frac{t_{acc}}{\text{Gate time}} \right) \times \frac{\text{Frequency}}{\text{or period}}$$

	53131A $t_{acc}$	53132A $t_{acc}$	53181A $t_{acc}$
Typical	350 ps	100 ps	350 ps
Worst case	1.25 ns	500 ps	1.25 ns

**Trigger:** Default setting is auto trigger at 50%

For time or digits arming:

$$\text{LSD displayed: } \left( \frac{2\sqrt{2} \times t_{res}}{\text{Gate time} \times \sqrt{\text{Number of samples}}} + \frac{t_{jitter}}{\text{Gate time}} \right) \times \frac{\text{Frequency}}{\text{or period}}$$

$$\text{RMS resolution (see graph 2): } \left( \frac{4 \times \sqrt{t_{res}^2 + (2 \times \text{Trigger error})^2}}{\text{Gate time} \times \sqrt{\text{Number of samples}}} + \frac{t_{jitter}}{\text{Gate time}} \right) \times \frac{\text{Frequency}}{\text{or period}}$$

	53131A/181A		53132A	
	$t_{res}$	$t_{jitter}$	$t_{res}$	$t_{jitter}$
Typical	500 ps	50 ps	225 ps	3 ps

See graphs for worst case resolution performance

Number of samples = Gate time × Frequency (Frequency < 200 kHz)  
Gate time × 200,000 (Frequency > 200 kHz)

$$\text{Systematic uncertainty: } \left( \pm \text{Time base error} \pm \frac{t_{acc}}{\text{Gate time}} \right) \times \frac{\text{Frequency}}{\text{or period}}$$

	53131A/181A $t_{acc}$	53132A $t_{acc}$
Typical	100 ps	10 ps
Worst case	300 ps	100 ps

**Trigger:** Default setting is auto trigger at 50%

# Measurement Specifications

## Frequency (53131A, 53132A, 53181A)

Channel 1 and 2 (53131A, 53132A)  
Channel 1 (53181A)

Range 0.1 Hz to 225 MHz

Channel 3 (53131A, 53132A)  
Channel 2 (53181A)

Option 015 100 MHz to 1.5 GHz  
(53181A only)

Option 030 100 MHz to 3 GHz

Option 050 200 MHz to 5 GHz

Option 124 200 MHz to 12.4 GHz

(Period 2 or 3 selectable via GPIB only)

## Period (53131A, 53132A, 53181A)

Channel 1 and 2 (53131A, 53132A)  
Channel 1 (53181A)

Range 4.44 ns to 10 s

Channel 3 (53131A, 53132A)  
Channel 2 (53181A)

Option 015 0.66 ns to 10 ns  
(53181A only)

Option 030 0.33 ns to 10 ns

Option 050 0.2 ns to 5 ns

Option 124 80 ps to 5 ns

## Frequency ratio (53131A, 53132A, 53181A)

Measurement is specified over the full signal range of each input.

Results range  $10^{-10}$  to  $10^{11}$

"Auto" gate time 100 ms

## Time interval (53131A, 53132A)

Measurement is specified over the full signal ranges of Channels 1 and 2.

Results range  $-1$  ns to  $10^5$  s

LSD 500 ps (53131A)/150 ps (53132A)

## Phase (53131A, 53132A)

Measurement is specified over the full signal range of Channels 1 and 2.

Results range  $-180^\circ$  to  $+360^\circ$

## Duty cycle (53131A, 53132A)

Measurement is specified over the full signal range of Channel 1. However, both the positive and negative pulse widths must be greater than 4 ns.

Results range 0 to 1 (e.g. 50% duty cycle would be displayed as .5)

## Rise/fall time (53131A, 53132A)

Measurement is specified over the full signal ranges of Channel 1. The interval between the end of one edge and start of a similar edge must be greater than 4 ns.

Edge selection Positive or negative

Trigger Default setting is auto trigger at 10% and 90%

Results range 5 ns to  $10^5$  s

LSD 500 ps (53131A)/150 ps (53132A)

## Pulse width (53131A, 53132A)

Measurement is specified over the full signal range of Channel 1. The width of the opposing pulse must be greater than 4 ns.

Pulse selection Positive or negative

Trigger Default setting is auto trigger at 50%

Results range 5 ns to  $10^5$  s

LSD 500 ps (53131A)/150 ps (53132A)

## Totalize (53131A, 53132A)

Measurement is specified over the full signal range of Channel 1.

Results range 0 to  $10^{15}$

Resolution  $\pm 1$  count

## Peak volts (53131A, 53132A, 53181A)

Measurement is specified on Channels 1 and 2 for dc signals; or for ac signals of frequencies between 100 Hz and 30 MHz with peak-to-peak amplitude greater than 100 mV.

Results range  $-5.1$  V to  $+5.1$  V

Resolution 10 mV

## Peak volts systematic uncertainty

for ac signals: 25 mV + 10% of V

for dc signals: 25 mV + 2% of V

Use of the input attenuator multiplies all voltage specifications (input range, results range, resolution and systematic uncertainty) by a nominal factor of 10.

## Gate time

Auto mode, or 1 ms to 1000 s

## Measurement throughput

GPIB ASCII 200 measurements/s (maximum)

## Measurement arming

Start Free run, manual, or external measurement

Stop Continuous, single, external, or timed measurement

Time interval 100  $\mu$ s to 10 s (53131A)

Delayed arming 100 ns to 10 s (53132A)

## Arming modes

(Note that not all arming modes are available for every measurement function.)

5. Available for all measurements except peak volts. External arm is referred to as external gate for some measurements.

6. See specifications for pulse width and rise/fall time measurements for additional restrictions on signal timing characteristics.

**Time interval, pulse width, rise/fall time (53131A and 53132A only):**

**RMS resolution:**  $\sqrt{(t_{res})^2 + \text{Start trigger error}^2 + \text{Stop trigger error}^2}$

**Systematic uncertainty:**

$\pm (\text{Time base error} \times \text{Measurement})$  Trigger level timing error  $\pm 1.5$  ns Differential channel error (53131A)  
 $\pm (\text{Time base error} \times \text{Measurement})$  Trigger level timing error  $\pm 900$  ps Differential channel error (53132A)  
 where  $t_{res} = 750$  ps for the 53131A, 300 ps for the 53132A

**Frequency ratio:**  $\frac{Ch1}{Ch2} \frac{Ch1}{Ch3} \frac{Ch2}{Ch1} \frac{Ch3}{Ch1}$  (53131A and 53132A)  $\frac{Ch1}{Ch2} \frac{Ch2}{Ch1}$  (53181A)

**LSD: Ratio  $\frac{1}{2}$ :**  $\frac{1}{Ch2 \text{ Freq} \times \text{Gate time}}$  **Ratio  $\frac{2}{1}$ :**  $\frac{Ch2 \text{ Freq}}{(Ch1 \text{ Freq})^2 \times \text{Gate time}}$

**RMS Resolution: Ratio  $\frac{1}{2}$ :**  $\frac{2 \times \sqrt{1 + (Ch1 \text{ Freq} \times Ch2 \text{ Trigger error})^2}}{Ch2 \text{ Freq} \times \text{Gate time}}$

**Ratio  $\frac{2}{1}$ :**  $\frac{2 \times Ch2 \text{ Freq} \times \sqrt{1 + (Ch1 \text{ Freq} \times Ch2 \text{ Trigger error})^2}}{(Ch1 \text{ Freq})^2 \times \text{Gate time}}$

For measurements using Ch3, substitute Ch3 for Ch2 in these equations. To minimize relative phase measurement error, connect the higher frequency signal to channel 1.

**Systematic uncertainty:**  $\pm 2x$  resolution

**Phase (53131A and 53132A)**

**RMS resolution:**  $\sqrt{((T_{res})^2 + (2 \times \text{Trigger error}^2)) \times \left(1 + \left(\frac{\text{Phase}}{360^\circ}\right)^2\right) \times \text{Frequency} \times 360^\circ}$

**Systematic uncertainty:**

$(\pm \text{Trigger level timing error} \pm 1.5$  ns Differential channel error)  $\times \text{Frequency} \times 360^\circ$  (53131A)  
 $(\pm \text{Trigger level timing error} \pm 900$  ps Differential channel error)  $\times \text{Frequency} \times 360^\circ$  (53132A)

**Duty cycle (53131A and 53132A)**

**RMS resolution:**  $\sqrt{((T_{res})^2 + (2 \times \text{Trigger error}^2)) \times (1 + \text{Duty cycle}^2) \times \text{Frequency}}$

$t_{res}$	53131A	53132A
	750 ps	300 ps

**Auto arming:** Measurements are initiated immediately and acquired as fast as possible, using a minimum number of signal edges.

**Timed arming:** The duration of the measurement is internally timed to a user-specified value (also known as the “gate time”).

**Digits arming:** Measurements are performed to the requested resolution (number of digits) through automatic selection of the acquisition time.

**External arming:** An edge on the external arm input enables the start of each measurement. Auto arming, timed arming modes or another edge on the external arm input may be used to complete the measurement.

**Time interval delayed arming:** For time interval measurements, the stop trigger condition is inhibited for a user-specified time following the start trigger. The 53132A offers advanced time interval arming capabilities including use of user specified time or Channel 2 events to delay both start and stop triggers.

**Measurement limits**

**Limit checking:** The measurement value is checked against user-specified limits at the end of each measurement.

**Display modes:** The measurement result may be displayed as either the traditional numeric value or graphically as an asterisk moving between two vertical bars.

**Out-of-limits Indications:**

- The limits annunciator will light on the front panel display.
- The instrument will generate an SRQ if enabled via GPIB.
- The limits hardware signal provided via the RS-232 connector will go low for the duration of the out-of-limit condition.
- If the analog display mode is enabled, the asterisk appears outside the vertical bars, which define the upper and lower limits.

Fractional time base error (see graph 3)

Time base error is the maximum fractional frequency variation of the time base due to aging or fluctuations in ambient temperature or line voltage:

$$\text{Time base error} = \left( \frac{\Delta f}{f} \text{ Aging rate} + \frac{\Delta f}{f} \text{ Temperature} + \frac{\Delta f}{f} \text{ Line voltage} \right)$$

Multiply this quantity by the measurement result to yield the absolute error for that measurement. Averaging measurements will not reduce (fractional) time base error. The counters exhibit negligible sensitivity to line voltage; consequently the line voltage term may be ignored.

---

Trigger error

External source and input amplifier noise may advance or delay the trigger points that define the beginning and end of a measurement. The resulting timing uncertainty is a function of the slew rate of the signal and the amplitude of spurious noise spikes (relative to the input hysteresis band).

The (rms) trigger error associated with a single trigger point is:

$$\text{Trigger error} = \frac{\sqrt{(E_{input})^2 + (E_{signal})^2}}{\text{Input signal slew rate at trigger point}} \quad (\text{in seconds})$$

where

$E_{input}$  = RMS noise of the input amplifier: 1 mVrms (350  $\mu$ Vrms typical). Note that the internal measurement algorithms significantly reduce the contribution of this term.

$E_{signal}$  = RMS noise of the input signal over a 225 MHz bandwidth (100 kHz bandwidth when the low-pass filter is enabled). Note that the filter may substantially degrade the signal's slew rate at the input of the trigger comparator.

For two-trigger-point measurements (e.g. rise time, pulse width), the trigger errors will be referred to independently as start trigger error and stop trigger error.

---

Trigger level timing error (see graph 6)

Trigger level timing error results from a deviation of the actual trigger level from the specified level. The magnitude of this error depends on resolution and accuracy of the trigger level circuit, input amplifier fidelity, input signal slew rate, and width of the input hysteresis band.

The following equations should be summed together to obtain the overall trigger level timing error.

At the "High" sensitivity input setting, the hysteresis band can be assumed to be the sensitivity of the counter input (see page 2). Reduction of input sensitivity or use of the attenuator will increase the size of this band.

$$\text{Input hysteresis error:} \quad \frac{0.5 \times \text{hysteresis band}}{\text{Input signal slew rate at start trigger point}} - \frac{0.5 \times \text{hysteresis band}}{\text{Input signal slew rate at stop trigger point}}$$

$$\text{Trigger level setting error:} \quad \pm \frac{15 \text{ mV} \pm (1\% \times \text{start trigger level setting})}{\text{Input signal slew rate at start trigger point}} \pm \frac{15 \text{ mV} \pm (1\% \times \text{stop trigger level setting})}{\text{Input signal slew rate at stop trigger point}}$$

---

Differential channel error

The differential channel error term stated in several systematic uncertainty equations accounts for channel-to-channel mismatch and internal noise. This error can be substantially reduced by performing a TI calibration (accessible via the utility menu) in the temperature environment in which future measurements will be made.



**Graph 1:**  
Keysight 53131A/181A–Worst case  
RMS resolution<sup>7</sup>  
(Automatic or external arming)

The graphs may also be used to compute errors for period measurements. To find the period error (DP), calculate the frequency of the input signal ( $F = 1/P$ ) and find the frequency error (DF) from the chart.

Then calculate the period error as:

$$\Delta P = \left( \frac{\Delta F}{F} \right) \times P$$

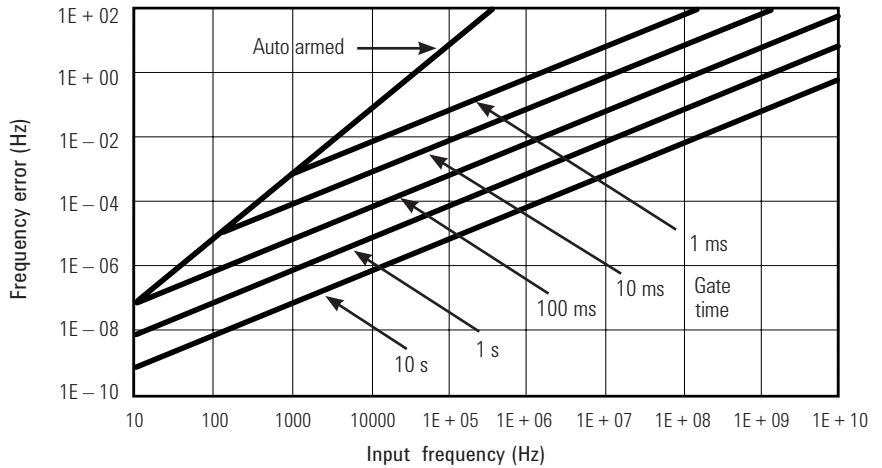

**Graph 2:**  
Keysight 53131A/181A–Worst case  
RMS resolution<sup>7</sup>  
(Time or digits arming)

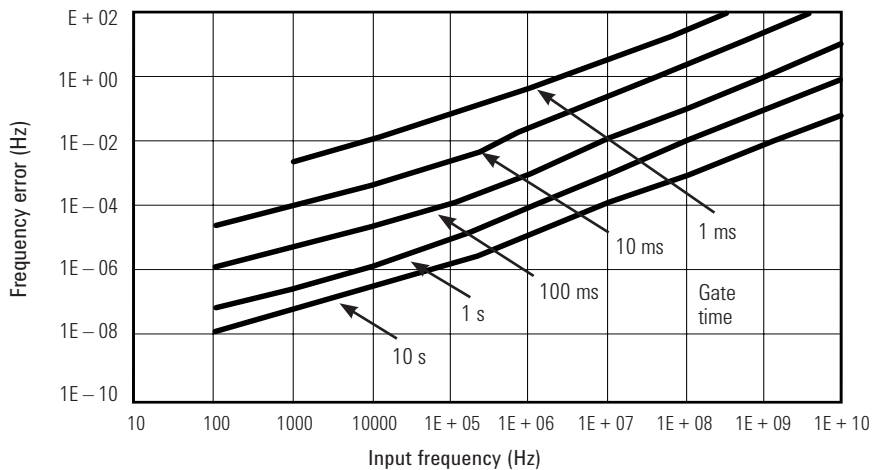

**Graph 3:**  
Timebase error

7. Graphs 1, 2, 4 and 5 do not reflect the effects of trigger error. To place an upper bound on the added effect of this error term, determine the frequency error from the appropriate graph and add a trigger error term as follows:

Time or digit arming

$$\text{Frequency error} + \left( \frac{4 \times \sqrt{2} \times \text{Trigger error}}{\text{Gate time} \times \sqrt{\text{Number of samples}}} \right) \times \frac{\text{Frequency or period}}$$

Automatic or external arming

$$\text{Frequency error} + \left( \frac{\sqrt{2} \times \text{Trigger error}}{\text{Gate time}} \right) \times \frac{\text{Frequency or period}}$$

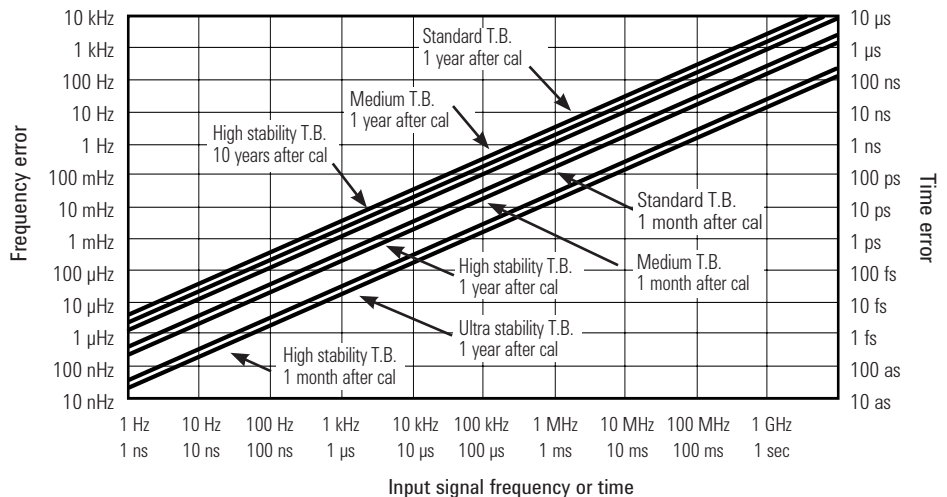

Graph 4:  
Keysight 53132A—Worst case  
RMS resolution<sup>7</sup>  
(Automatic or external arming)

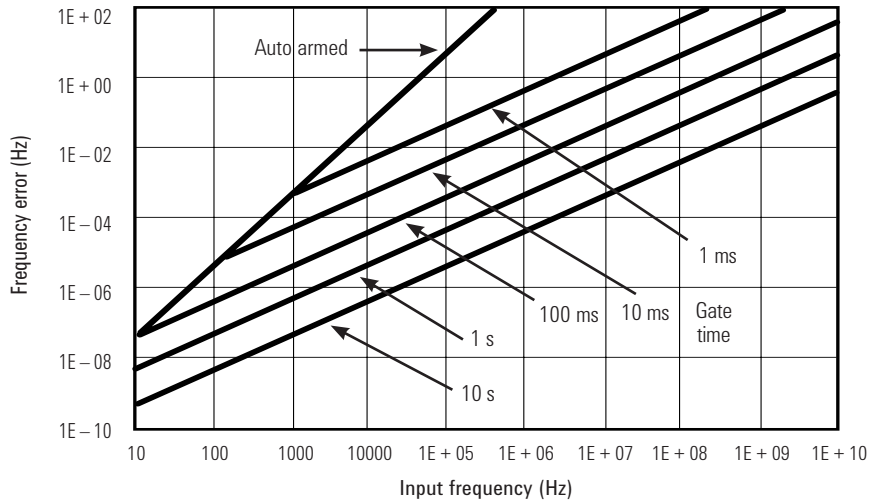

Graph 5:  
Keysight 53132A—Worst case  
RMS resolution<sup>7</sup>  
(Time or digits arming)

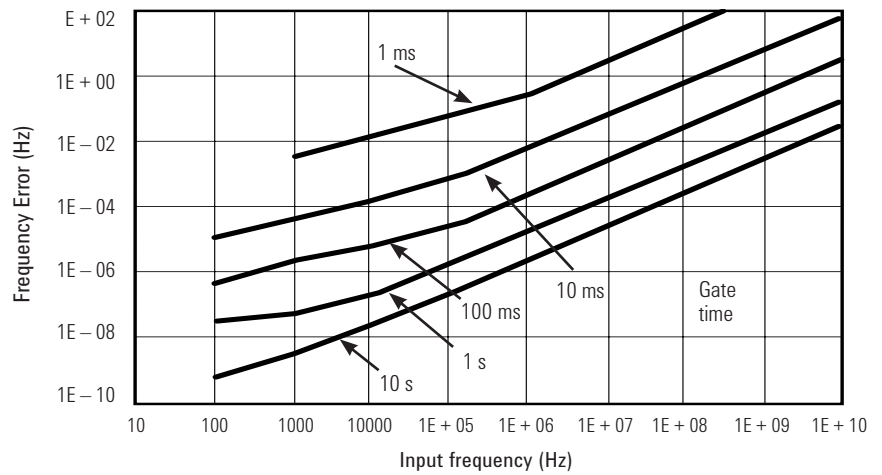

Graph 6:  
Trigger level timing error  
(Level setting error and  
input hysteresis)

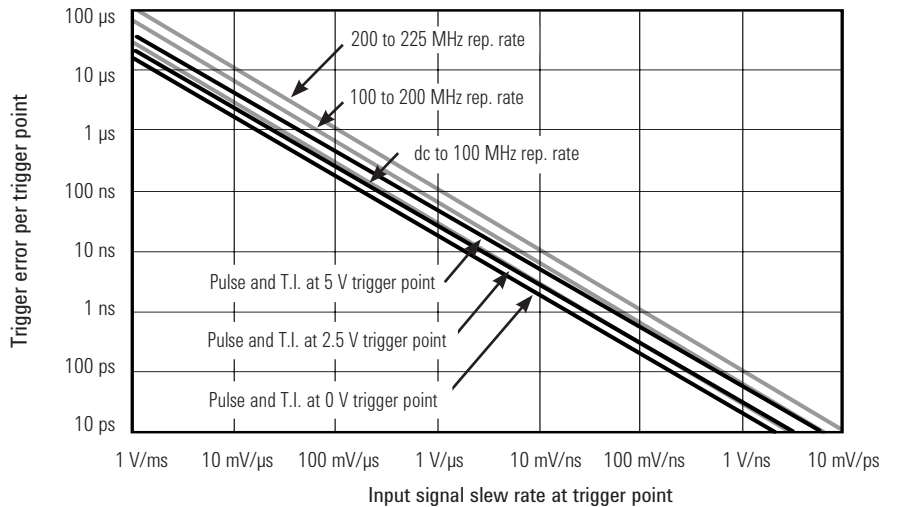

7. Graphs 1, 2, 4 and 5 do not reflect the effects of trigger error. To place an upper bound on the added effect of this error term, determine the frequency error from the appropriate graph and add a trigger error term as follows:

Time or digit arming

$$\text{Frequency error} + \left( \frac{4 \times \sqrt{2} \times \text{Trigger error}}{\text{Gate time} \times \sqrt{\text{Number of samples}}} \right) \times \frac{\text{Frequency or period}}$$

Automatic or external arming

$$\text{Frequency error} + \left( \frac{\sqrt{2} \times \text{Trigger error}}{\text{Gate time}} \right) \times \frac{\text{Frequency or period}}$$

## Measurement Statistics

### Available statistics

---

Mean, Minimum, Maximum, Standard Deviation

Number of measurements 2 to 1,000,000.

---

Statistics may be collected on all measurements or on only those which are between the limit bands. When the limits function is used in conjunction with statistics, N (number of measurements) refers to the number of in-limit measurements. In general, measurement resolution will improve in proportion to N, up to the numerical processing limits of the instrument.

### Measurements

---

Statistics may be collected for all measurements except peak volts and totalize.

## General Information

### Save and recall

---

Up to 20 complete instrument setups may be saved and recalled later. These setups are retained when power is removed from the counter.

### Rack dimensions (HxWxD)

---

88.5 mm x 212.6 mm x 348.3 mm

### Weight

---

3.5 kg maximum

### Warranty

---

3 year

### Power supply

---

100 to 120 VAC  $\pm$  10% -50, 60 or  
400 Hz  $\pm$  10% 220 to 240 VAC  
 $\pm$  10% -50 or 60 Hz  $\pm$  10%

### ac Line selection

---

Automatic

### Power requirements

---

170 VA maximum (30 W typical)

### Environment

---

0 to 55 °C operating  
-40 to 71 °C storage

### Remote Interface

---

GPIB (IEEE 488.1-1987,  
IEEE 488.2-1987)

### Remote programming language

---

SCPI-1992.0 (Standard Commands  
for Programmable Instruments)

### Safety

---

Designed in compliance with IEC-1010,  
UL-3111-1 (draft), CAN/CSA 1010.1

### EMC

---

CISPR-11, EN50082-1,  
IEC 801-2, -3, -4

### Radiated immunity testing

---

When the product is operated at maximum sensitivity (20 mVrms) and tested at 3 V/m according to IEC 801-3, external 100 to 200 MHz electric fields may cause frequency miscounts.

## Ordering Information

### 53131A

10 digit/s, 500 ps universal counter

### 53132A

12 digit/s, 150 ps universal counter

### 53181A

10-digit/s RF counter

#### Accessories included

Each counter comes with IntuiLink software, standard timebase, and power cord. CD with the following: IntuiLink software, Operating, Programming, Service and Getting Started Guides, a data sheet, and application notes.

## Manual options

(please specify one when ordering)

ABA US English

ABD German

ABE Spanish

ABF French

ABJ Japanese

ABZ Italian

AB0 Taiwan Chinese

AB1 Korean

AB2 Chinese

#### Other options

Opt. 001 Medium-stability timebase

Opt. 010 High-stability timebase

Opt. 012 Ultra-high stability timebase (53132A only)

Opt. 015 1.5 GHz RF input Ch 2 for 53181A only

Opt. 030 3 GHz RF input Ch 3 (Ch 2 on 53181A)

Opt. 050 5 GHz RF input with type N connector Ch 3 (Ch 2 on 53181A)

Opt. 124 12.4 GHz RF input with type N connector Ch 3 (Ch 2 on 53181A)

Opt. 060 Rear-panel connectors\*

Opt. A6J ANSI Z540 compliant calibration

#### \*Opt 060 configuration table

##### 53131A/132A

Ch1 & Ch2 front & rear (in parallel)

Ch3 Opt. 030 rear only, front plugged

Ch3 Opt. 050/124 front only

Ch2 Opt. 050/124 front only

##### 53181

Ch1 front & rear (in parallel)

Ch2 Opt. 015/030 rear only, front plugged

Ch2 Opt. 050/124 front only

#### Accessories

34131A Hard carrying case

34161A Accessory pouch

34190A Rackmount kit: designed for use with only one instrument, mounted on either the left or the right side of the rack.

34191A 2U dual flange kit: secures the instrument to the front of the rack. This kit can be used with the 34194A dual lock link kit to mount two half-width, 2U height instruments side-by-side.

34194A Dual lock link kit: recommended for side-by-side combinations and includes links for instruments of different depths. This kit can be used with the 34191A 2U dual flange kit to mount two half-width, 2U height instruments side-by-side.

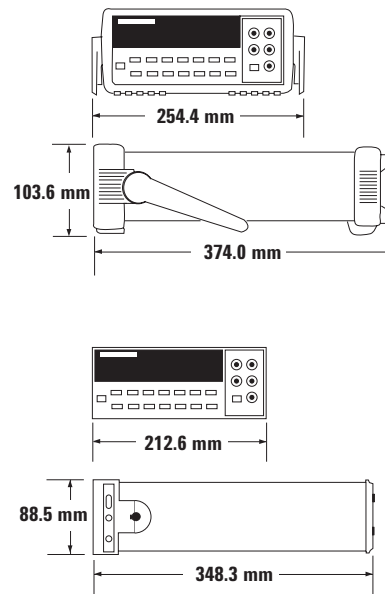

**myKeysight**

**myKeysight**

[www.keysight.com/find/mykeysight](http://www.keysight.com/find/mykeysight)

A personalized view into the information most relevant to you.



[www.axiestandard.org](http://www.axiestandard.org)

AdvancedTCA® Extensions for Instrumentation and Test (AXIe) is an open standard that extends the AdvancedTCA for general purpose and semiconductor test. Keysight is a founding member of the AXIe consortium.



[www.lxistandard.org](http://www.lxistandard.org)

LAN eXtensions for Instruments puts the power of Ethernet and the Web inside your test systems. Keysight is a founding member of the LXI consortium.



[www.pxisa.org](http://www.pxisa.org)

PCI eXtensions for Instrumentation (PXI) modular instrumentation delivers a rugged, PC-based high-performance measurement and automation system.



**Three-Year Warranty**

[www.keysight.com/find/ThreeYearWarranty](http://www.keysight.com/find/ThreeYearWarranty)

Keysight's commitment to superior product quality and lower total cost of ownership. The only test and measurement company with three-year warranty standard on all instruments, worldwide.



**Keysight Assurance Plans**

[www.keysight.com/find/AssurancePlans](http://www.keysight.com/find/AssurancePlans)

Up to five years of protection and no budgetary surprises to ensure your instruments are operating to specification so you can rely on accurate measurements.



[www.keysight.com/quality](http://www.keysight.com/quality)

Keysight Electronic Measurement Group  
DEKRA Certified ISO 9001:2008  
Quality Management System

**Keysight Channel Partners**

[www.keysight.com/find/channelpartners](http://www.keysight.com/find/channelpartners)

Get the best of both worlds: Keysight's measurement expertise and product breadth, combined with channel partner convenience.

[www.keysight.com/find/counters](http://www.keysight.com/find/counters)

For more information on Keysight Technologies' products, applications or services, please contact your local Keysight office. The complete list is available at: [www.keysight.com/find/contactus](http://www.keysight.com/find/contactus)

**Americas**

Canada	(877) 894 4414
Brazil	55 11 3351 7010
Mexico	001 800 254 2440
United States	(800) 829 4444

**Asia Pacific**

Australia	1 800 629 485
China	800 810 0189
Hong Kong	800 938 693
India	1 800 112 929
Japan	0120 (421) 345
Korea	080 769 0800
Malaysia	1 800 888 848
Singapore	1 800 375 8100
Taiwan	0800 047 866
Other AP Countries	(65) 6375 8100

**Europe & Middle East**

Austria	0800 001122
Belgium	0800 58580
Finland	0800 523252
France	0805 980333
Germany	0800 6270999
Ireland	1800 832700
Israel	1 809 343051
Italy	800 599100
Luxembourg	+32 800 58580
Netherlands	0800 0233200
Russia	8800 5009286
Spain	0800 000154
Sweden	0200 882255
Switzerland	0800 805353
	Opt. 1 (DE)
	Opt. 2 (FR)
	Opt. 3 (IT)
United Kingdom	0800 0260637

For other unlisted countries:  
[www.keysight.com/find/contactus](http://www.keysight.com/find/contactus)  
(BP-06-16-14)

